

# Panasonic

# EUROPA

PRECISION.  
PERFECTION.  
PERFORMANCE.



Our Pricelist is now  
**Available Online**  
Scan & download

PRICELIST: **APRIL 2026**

# EUROPA





Presenting the EUROPA Series, a range of switches that have been designed to provide convenience along with perfect functionality. EUROPA Series, a range of switches that complement your strong aesthetic sense. While its list of features seems endless, it is the elegant look and finish of the switches that is most striking.

Give your home a touch of elegance with EUROPA.

classy

STYLE ON  
WITH PERFECTION

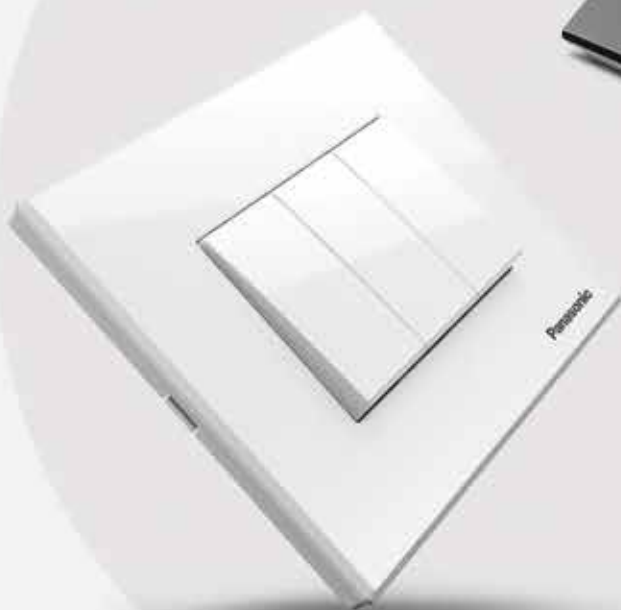

A finish that's so crisp and contemporary. It undeniably sits in your space without fighting for attention, yet making everything look so classy. If your definition of style is sophistication, class and minimalism, well, this one's made just for your walls.





# glare

SHINE ON  
WITH GLASS



Match or contrast or simply make it stand out. Creativity to decorate and art. Use clear and glass plates to accentuate the wall designs and patterns. Add some dramatic accessories to your walls.



metal

SWITCH ON  
WITH DAZZLE

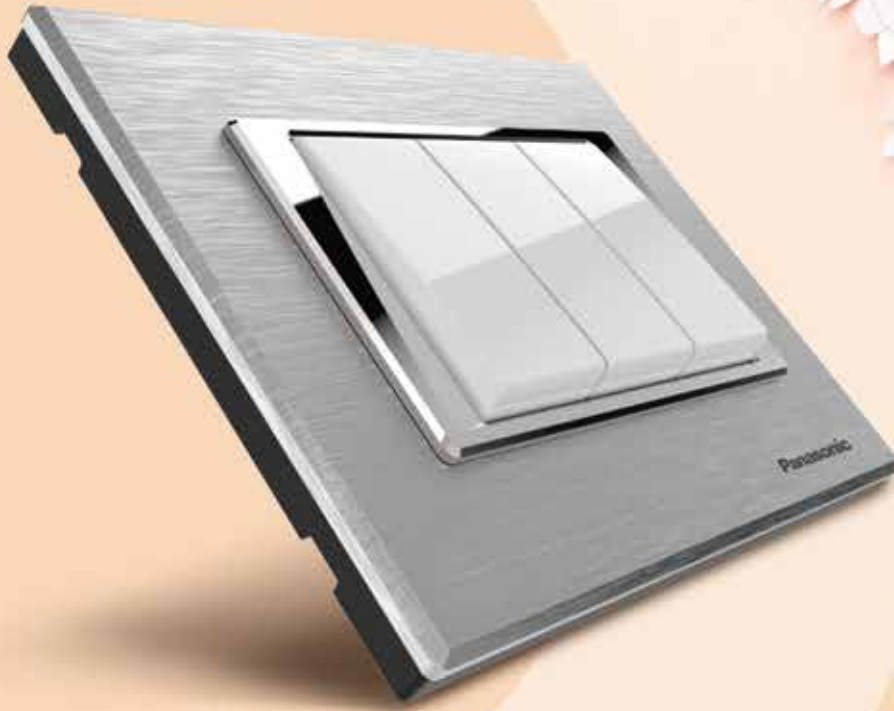

An epitome of luxury, metallic always makes your space a tad more stylish. When things dazzle, a statement is made. Add an touch of class with the Metallic look.



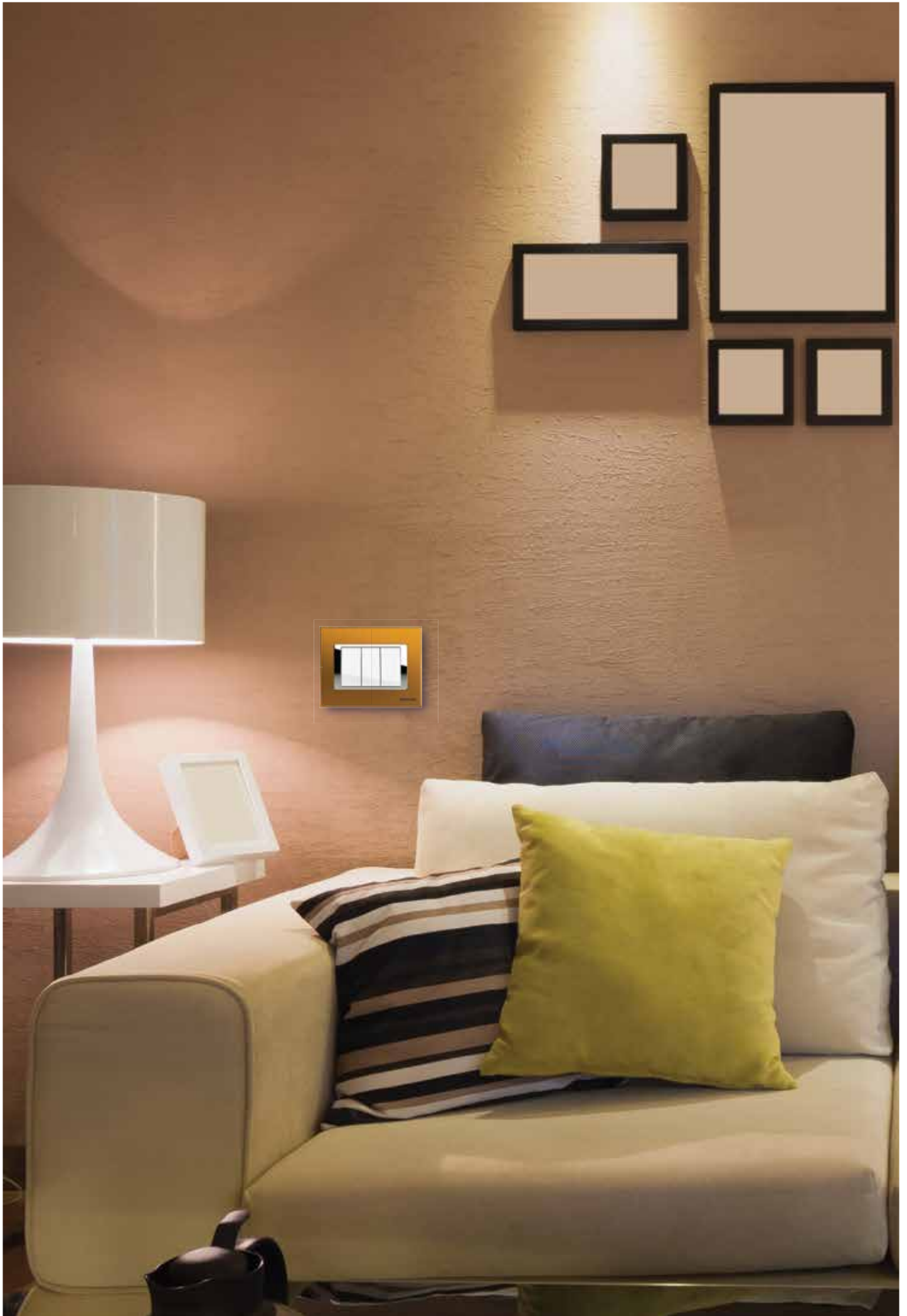

## Flame Retardant

- Flame retardant (Resist fire)
- Difficult to mould therefore duplicacy of product is very difficult
- Urea formaldehyde has high flame retardant properties as compared to PC or other thermoplastic



Front Polycarbonate of (V0 Grade)

Back Piece Urea Material

## Super Glossy Finish



- Premium look
- Dust does not settle easily
- Glossiness readings = > G140
- Almost matches glossiness of glass plate



## Toggle Type Structure

- 1 Pillar Terminals (Brass + Silver Flash)
- 2 Terminal Screws (Brass + Silver Flash)
- 3 Contact Bridge (Brass)
- 4 Switch Housing (Urea)

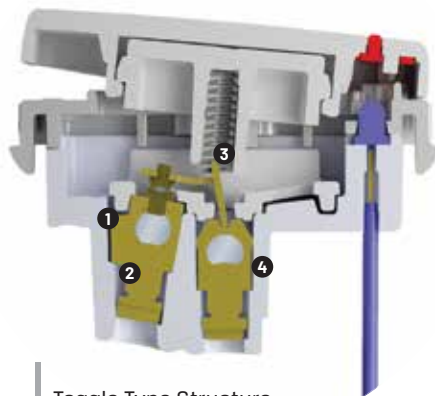

Toggle Type Structure

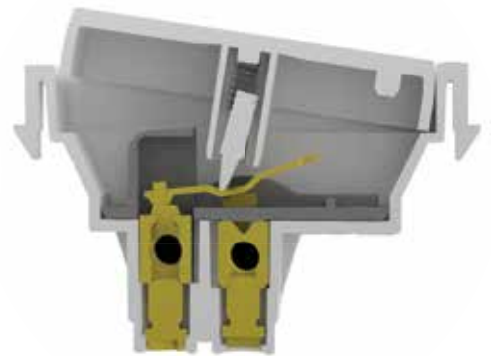

Normal Switch Structure

- Increased life and smooth operation
- Less Sound
- Less Bounce
- Contact Gap = Mini Gap

### Switch - Moving Contact Tip Properties

"AgCd0" bimetals offers increased resistance to welding and erosion.

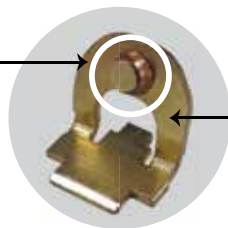

Brass moving contact prevents rusting of the part, and offers better dimensional stability throughout its life.

## "All Sockets with Safety Shutter"

Child safety against electric shock.  
Smooth insertion & withdrawal of plugs.



## Plate Structure

### Plate fitment with metal inserts



Plate

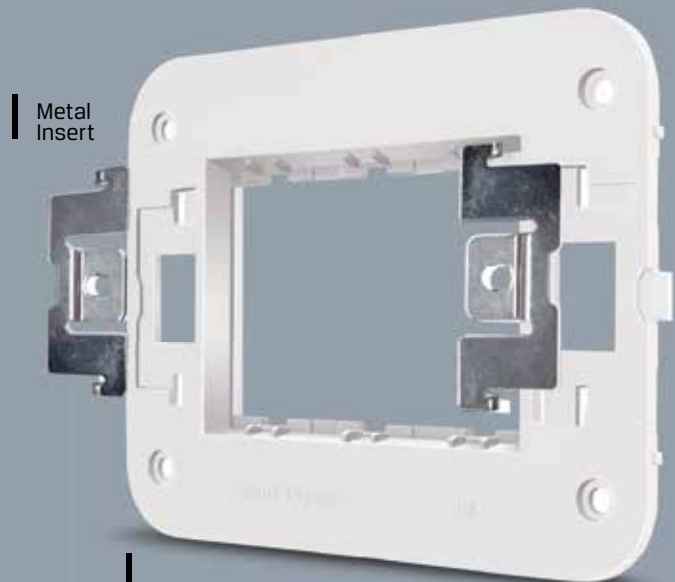

Base Frame

- Improve overall strength of the inner frame
- Sturdy plates
- Reduces possibility of plate damages

## Slim & Sleek Design

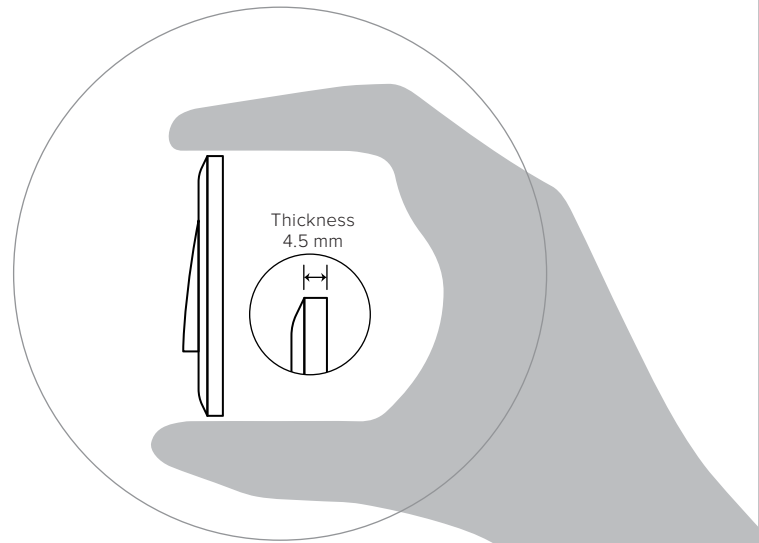
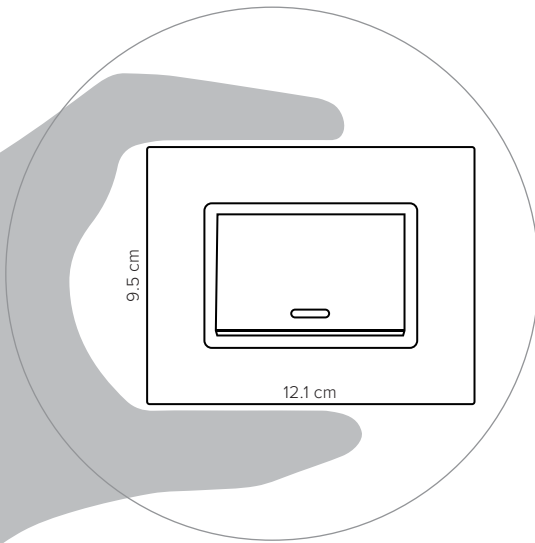

- Better Aesthetic
- Blends with the wall and gives a very sleek look

## Low Operational Sound

### Switches with reduced sound

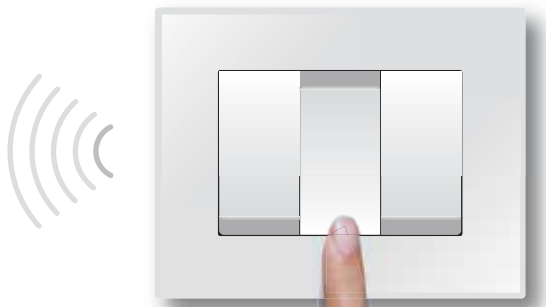

- Sound level < 65 Db
- Soft operational sound

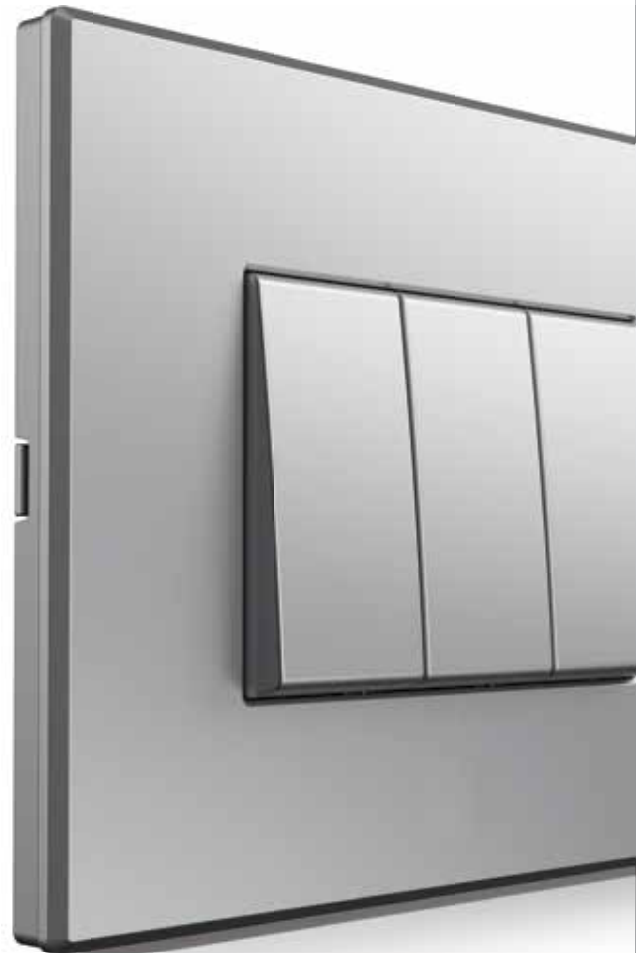

## Front Removal Accessories



Easy installation from the front



Easy removal from the front

- Easy to install and uninstall the accessories
- No need to remove the inner frame from metal box and hence it is safe & saves time

## 1 Lac Operations

- Product durability
- No need to worry for years to come

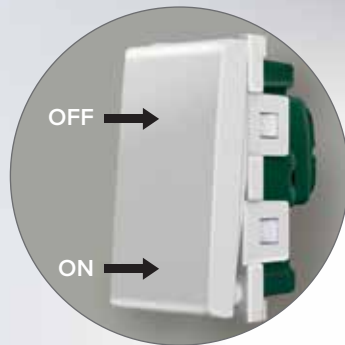

## IP20 Protection

- No live part is exposed to fingers and can be accessible only through screwdriver
- Protects against solid object larger than 12mm
- Completely insulated construction



## RoHS Compliant

Panasonic is committed towards making a positive & proactive contribution to the community.

So we highly pays attention to protect global environment and relieve environmental load from our business operation, complying with the RoHS directive.

### Restriction of Hazardous Substances (RoHS) regulations set limits for the use of following substances

- Lead (Pb)
- Cadmium (Cd)
- Mercury (Hg)
- Hexavalent Chromium (Cr+6)
- Specified Brominated Flame Retardants (PBB, PBDE)
- Phthalates - Four kinds: (DEHP, BBP, DBP, DIBP)



100%  
ECO Friendly







Increase  
Production  
Efficiency







Improve  
Quality

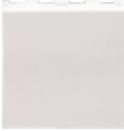









10AX Switches (240V-50Hz), ISI

						
<b>Code</b>	WIPM5011	WIPM5111	WIPM5012	WIPM50119	WIPM51119	WIPM5021
<b>Description</b>	10AX, 1Way Switch, 1 Module, 100W, SLB Load	10AX, 1Way Switch with Indicator, 1 Module, 100W, SLB Load	10AX, 2Way Switch, 1 Module, 100W, SLB Load	10A, Bell Push Switch, 1 Module	10A, Bell Push Switch with Indicator, 1 Module	10AX, 1Way Switch, 2 Module, 100W, SLB Load
<b>HSN</b>	85361010	85361010	85361010	85361010	85361010	85361010
<b>Unit Sale Price Rs per number</b>	207	271	244	268	349	292
<b>Maximum Retail Price (Inclusive of all taxes) Rs.</b>	4140	5420	4880	5360	6980	2920
<b>Standard Packing Quantity (Number)</b>	20	20	20	20	20	10



					
<b>Code</b>	WIPM5121	WIPM5022	WIPM50219	WIPM51219	WIPM51319
<b>Description</b>	10AX, 1Way Switch with Indicator, 2 Module, 100W, SLB Load	10AX, 2Way Switch, 2 Module, 100W, SLB Load	10A, Bell Push Switch, 2 Module	10A, Bell Push Switch with Indicator, 2 Module	10A, Bell Push Switch with Indicator, 3 Module
<b>HSN</b>	85361010	85361010	85361010	85361010	85361010
<b>Unit Sale Price Rs per number</b>	323	336	336	401	450
<b>Maximum Retail Price (Inclusive of all taxes) Rs.</b>	3230	3360	3360	4010	2250
<b>Standard Packing Quantity (Number)</b>	10	10	10	10	5

20A Switches (240V-50Hz), ISI

						
<b>Code</b>	WIPM50115	WIPM51115	WIPM50125	WIPM50215	WIPM51215	WIPM50225
<b>Description</b>	20A, 1Way Switch, 1 Module	20A, 1Way Switch with Indicator, 1 Module	20A, 2Way Switch, 1 Module	20A, 1Way Switch, 2 Module	20A, 1Way Switch with Indicator, 2 Module	20A, 2Way Switch, 2 Module
<b>HSN</b>	85361020	85361020	85361020	85361020	85361020	85361020
<b>Unit Sale Price Rs per number</b>	326	339	382	408	533	416
<b>Maximum Retail Price (Inclusive of all taxes) Rs.</b>	6520	6780	7640	4080	5330	4160
<b>Standard Packing Quantity (Number)</b>	20	20	20	10	10	10

			
<b>Code</b>	WIPM50315	WIPM51315	WIPM50325
<b>Description</b>	20A, 1Way Switch, 3 Module	20A, 1Way Switch with Indicator, 3 Module	20A, 2Way Switch, 3 Module
<b>HSN</b>	85361020	85361020	85361020
<b>Unit Sale Price Rs per number</b>	481	599	592
<b>Maximum Retail Price (Inclusive of all taxes) Rs.</b>	2405	2995	2960
<b>Standard Packing Quantity (Number)</b>	5	5	5

Power Switches - Heavy Duty (240V-50Hz), ISI

		
<b>Code</b>	WIPM51113	WIPM51234
<b>Description</b>	25A, S.P, 1Way Switch with Indicator, 1 Module	32A, D.P, 1Way Switch with Indicator, 2 Module
<b>HSN</b>	85361020	85361020
<b>Unit Sale Price Rs per number</b>	609	1063
<b>Maximum Retail Price (Inclusive of all taxes) Rs.</b>	6090	10630
<b>Standard Packing Quantity (Number)</b>	10	10

Sockets with Safety Shutter (240V~50Hz)



<b>Code</b>	WIPM113214	WIPM123214	WIPM125214	WIPM155314
<b>Description</b>	6A, 3Pin Socket ( ISI ), 2 Module	16A, 3Pin Socket ( ISI ), 2 Module	16A/6A, Twin Socket, (ISI Mark), 2 Module	Twin Socket, 3 Module (ISI Mark),6A/16A, 240V~
<b>HSN</b>	85366910	85366910	85366910	85366910
<b>Unit Sale Price Rs per number</b>	<b>282</b>	<b>464</b>	<b>562</b>	<b>655</b>
<b>Maximum Retail Price (Inclusive of all taxes) Rs.</b>	2820	4640	5620	3275
<b>Standard Packing Quantity (Number)</b>	10	10	10	5



<b>Code</b>	WIPM4734
<b>Description</b>	25A, Motor Starter Switch, 2 Module
<b>HSN</b>	85395000
<b>Unit Sale Price Rs per number</b>	<b>777</b>
<b>Maximum Retail Price (Inclusive of all taxes) Rs.</b>	7770
<b>Standard Packing Quantity (Number)</b>	10

Fan Regulators & Dimmers (240V~50Hz)



<b>Code</b>	WIPM4951	WIPM4952**	WIPM495214**	WIPM5714	WIPM5726
<b>Description</b>	100W, Step Fan Regulator, 1 Module	100W, Step Fan Regulator, 2 Module	100W, Step Fan Regulator, 2 Module (ISI)	450W, Dimmer, 1 Module	650W, Dimmer, 2 Module
<b>HSN</b>	84149030	84149030	84149030	85365020	85365020
<b>Unit Sale Price Rs per number</b>	<b>777</b>	<b>1074</b>	<b>1120</b>	<b>927</b>	<b>1133</b>
<b>Maximum Retail Price (Inclusive of all taxes) Rs.</b>	15540	10740	11200	18540	11330
<b>Standard Packing Quantity (Number)</b>	20	10	10	20	10



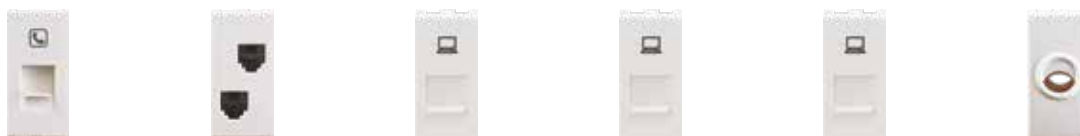



Support Modules (240V~50Hz)











<b>Code</b>	WIPM2164	WIPM2264	WIPM2499	WIPM2488	WIPM24886	WIPM3023
<b>Description</b>	RJ11, Tel Jack, Single with Shutter, 1 Module	RJ11, Tel Jack, Double w/o Shutter, 1 Module	RJ45, Receptor, 1 Module	RJ45, Computer Socket, Cat 5e, 1 Module	RJ45, Computer Socket, Cat 6, 1 Module	Cord Outlet with Grip, 1 Module
<b>HSN</b>	85366910	85366910	85366910	85366910	85366910	85366910
<b>Unit Sale Price Rs per number</b>	<b>251</b>	<b>419</b>	<b>244</b>	<b>803</b>	<b>941</b>	<b>281</b>
<b>Maximum Retail Price (Inclusive of all taxes) Rs.</b>	5020	8380	4880	16060	18820	5620
<b>Standard Packing Quantity (Number)</b>	20	20	20	20	20	20

\*\*Compatible with selected BLDC Fan models only



Support Modules (240V~50Hz)

						
<b>Code</b>	WIPM2501	WIPM4702	WIPM3020	WIPM3120	WIPM3032R	WIPM3032N
<b>Description</b>	TV Socket Outlet, 1 Module	Buzzer, 2 Module	Blank Plate, 1 Module	Blank Plate, 2 Module	Indicator - LED (Red), 1 Module	Indicator - LED (Natural), 1 Module
<b>HSN</b>	85365090	85318000	85389000	85389000	85395000	85395000
<b>Unit Sale Price Rs per number</b>	<b>258</b>	<b>777</b>	<b>60</b>	<b>98</b>	<b>328</b>	<b>328</b>
<b>Maximum Retail Price (Inclusive of all taxes) Rs.</b>	5160	7770	3000	1960	3280	3280
<b>Standard Packing Quantity (Number)</b>	20	10	50	20	10	10







						
<b>Code</b>	WIPM3032G	WIPM2731	WIPM1343	WIPM1341	WIPM1443	WIPM2641
<b>Description</b>	Indicator - LED (Green), 1 Module	Satellite Socket	18W, USB Type-A Fast Charger, 1 Module (CRS Certified)	USB-A Charger, Single Port(2.1A, 5V DC), 1 Module	18W, USB Power Delivery Charger(USB-C), 1 Module (CRS Certified)	High Definition Multimedia Interface Connector, 1 Module
<b>HSN</b>	85395000	85365090	85044090	85044090	85365090	85444999
<b>Unit Sale Price Rs per number</b>	<b>328</b>	<b>655</b>	<b>2127</b>	<b>1896</b>	<b>2238</b>	<b>1979</b>
<b>Maximum Retail Price (Inclusive of all taxes) Rs.</b>	3280	6550	42540	37920	44760	19790
<b>Standard Packing Quantity (Number)</b>	10	10	20	20	20	10

		
<b>Code</b>	WIPM4822	WIPM2311
<b>Description</b>	Audio Video Socket, 1 Module	Projector Socket, 1 Module
<b>HSN</b>	85365090	85044090
<b>Unit Sale Price Rs per number</b>	<b>944</b>	<b>2479</b>
<b>Maximum Retail Price (Inclusive of all taxes) Rs.</b>	9440	24790
<b>Standard Packing Quantity (Number)</b>	10	10

Hospitality Range (240V~50Hz)

		
<b>Code</b>	WIPM4661	WIPM4791
<b>Description</b>	3.5 Modulem Audio Jack, White	Bell Call Indicator, 1 Module
<b>HSN</b>	85444299	85444299
<b>Unit Sale Price Rs per number</b>	<b>1997</b>	<b>526</b>
<b>Maximum Retail Price (Inclusive of all taxes) Rs.</b>	29955	5260
<b>Standard Packing Quantity (Number)</b>	15	10

Hospitality Range (240V~50Hz)

						
<b>Code</b>	WIPM57812	WIPM500212	WIPM500213	WIPM1051	WIPM4013 / WIPM40131	WIPM4014 / WIPM40141
<b>Description</b>	20A, Electronic Key-card Unit with 30Sec time delay, 3 Module	DND MMR Internal unit ( DND Switch, MMR Switch), 2 Module	DND MMR External unit ( DND Indicator, MMR Indicator & Bell Push Switch), 2 Module	20VA, Shaver Socket with Transformer (With White Inner Frame), 4 Module	Foot Light - LED Based (Cool & Warm light), 3 Module	Foot Light - LED Based (Cool & Warm light), 4 Module
<b>HSN</b>	85365090	85365090	85365090	85365090	94054090	85444299
<b>Unit Sale Price Rs per number</b>	<b>3647</b>	<b>1019</b>	<b>1359</b>	<b>4009</b>	<b>983</b>	<b>1078</b>
<b>Maximum Retail Price (Inclusive of all taxes) Rs.</b>	21882	5095	6795	4009	5898	6468
<b>Standard Packing Quantity (Number)</b>	6	5	5	1	6	6

10AX Switches (240V~50Hz), ISI



<b>Code</b>	WIPM5011B	WIPM5111B	WIPM5012B	WIPM50119B	WIPM51119B	WIPM5021B
<b>Description</b>	10AX, 1Way Switch, 1 Module, 100W, SLB Load	10AX, 1Way Switch with Indicator, 1 Module, 100W, SLB Load	10AX, 2Way Switch, 1 Module, 100W, SLB Load	10A, Bell Push Switch, 1 Module	10A, Bell Push Switch with Indicator, 1 Module	10AX, 1Way Switch, 2 Module, 100W, SLB Load
<b>HSN</b>	85361010	85361010	85361010	85361010	85361010	85361010
<b>Unit Sale Price Rs per number</b>	227	309	276	306	395	331
<b>Maximum Retail Price (Inclusive of all taxes) Rs.</b>	4540	6180	5520	6120	7900	3310
<b>Standard Packing Quantity (Number)</b>	20	20	20	20	20	10



<b>Code</b>	WIPM5121B	WIPM5022B	WIPM50219B	WIPM51219B	WIPM51319B
<b>Description</b>	10AX, 1Way Switch with Indicator, 2 Module, 100W, SLB Load	10AX, 2Way Switch, 2 Module, 100W, SLB Load	10A, Bell Push Switch, 2 Module	10A, Bell Push Switch with Indicator, 2 Module	10A, Bell Push Switch with Indicator, 3 Module
<b>HSN</b>	85361010	85361010	85361010	85361010	85361010
<b>Unit Sale Price Rs per number</b>	363	381	381	454	509
<b>Maximum Retail Price (Inclusive of all taxes) Rs.</b>	3630	3810	3810	4540	2545
<b>Standard Packing Quantity (Number)</b>	10	10	10	10	5

20A Switches (240V~50Hz), ISI



<b>Code</b>	WIPM50115B	WIPM51115B	WIPM50125B	WIPM50215B	WIPM51215B	WIPM50225B
<b>Description</b>	20A, 1Way Switch, 1 Module	20A, 1Way Switch with Indicator, 1 Module	20A, 2Way Switch, 1 Module	20A, 1Way Switch, 2 Module	20A, 1Way Switch with Indicator, 2 Module	20A, 2Way Switch, 2 Module
<b>HSN</b>	85361020	85361020	85361020	85361020	85361020	85361020
<b>Unit Sale Price Rs per number</b>	370	384	431	461	603	471
<b>Maximum Retail Price (Inclusive of all taxes) Rs.</b>	7400	7680	8620	4610	6030	4710
<b>Standard Packing Quantity (Number)</b>	20	20	20	10	10	10



<b>Code</b>	WIPM50315B	WIPM51315B	WIPM50325B
<b>Description</b>	20A, 1Way Switch, 3 Module	20A, 1Way Switch with Indicator, 3 Module	20A, 2Way Switch, 3 Module
<b>HSN</b>	85361020	85361020	85361020
<b>Unit Sale Price Rs per number</b>	541	677	667
<b>Maximum Retail Price (Inclusive of all taxes) Rs.</b>	2705	3385	3335
<b>Standard Packing Quantity (Number)</b>	5	5	5

Power Switches - Heavy Duty (240V~50Hz), ISI



<b>Code</b>	WIPM51113B	WIPM51234B
<b>Description</b>	25A, S.P, 1Way Switch with Indicator, 1 Module	32A, D.P, 1Way Switch with Indicator, 2 Module
<b>HSN</b>	85361020	85361020
<b>Unit Sale Price Rs per number</b>	689	1206
<b>Maximum Retail Price (Inclusive of all taxes) Rs.</b>	6890	12060
<b>Standard Packing Quantity (Number)</b>	10	10









Sockets with Safety Shutter (240V-50Hz)							
	<b>Code</b>	WIPM113214B	WIPM123214B	WIPM125214B	WIPM155314B		
	<b>Description</b>	6A, 3Pin Socket ( ISI ), 2 Module	16A, 3Pin Socket (ISI), 2 Module	16A/6A, Twin Socket, (ISI Mark), 2 Module	Twin Socket, 3 Module (ISI Mark),6A/16A, 240V-		
	<b>HSN</b>	85366910	85366910	85366910	85366910		
	<b>Unit Sale Price Rs per number</b>	321	528	635	741		
	<b>Maximum Retail Price (Inclusive of all taxes) Rs.</b>	3210	5280	6350	3705		
	<b>Standard Packing Quantity (Number)</b>	10	10	10	5		
Fan Regulators & Dimmers (240V-50Hz)							
	<b>Code</b>	WIPM4951B	WIPM4952B**	WIPM495214B**	WIPM5714B	WIPM5726B	
	<b>Description</b>	100W, Step Fan Regulator, 1 Module	100W, Step Fan Regulator, 2 Module	100W, Step Fan Regulator, 2 Module (ISI)	450W, Dimmer, 1 Module	650W, Dimmer, 2 Module	
	<b>HSN</b>	84149030	84149030	84149030	85365020	85365020	
	<b>Unit Sale Price Rs per number</b>	878	1215	1264	1046	1281	
	<b>Maximum Retail Price (Inclusive of all taxes) Rs.</b>	17560	12150	12640	20920	12810	
	<b>Standard Packing Quantity (Number)</b>	20	10	10	20	10	
Support Modules (240V-50Hz)							
	<b>Code</b>	WIPM2164B	WIPM2264B	WIPM2499B	WIPM2488B	WIPM24886B	WIPM3023B
	<b>Description</b>	RJ11, Tel Jack, Single with Shutter, 1 Module	RJ11, Tel Jack, Double w/o Shutter, 1 Module	RJ45, Receptor, 1 Module	RJ45, Computer Socket, Cat 5e, 1 Module	RJ45, Computer Socket, Cat 6, 1 Module	Cord Outlet with Grip, 1 Module
	<b>HSN</b>	85366910	85366910	85366910	85366910	85366910	85366910
	<b>Unit Sale Price Rs per number</b>	284	474	278	908	1065	319
	<b>Maximum Retail Price (Inclusive of all taxes) Rs.</b>	5680	9480	5560	18160	21300	6380
	<b>Standard Packing Quantity (Number)</b>	20	20	20	20	20	20

\*\*Compatible with selected BLDC Fan models only



Support Modules (240V~50Hz)





						
<b>Code</b>	WIPM2501B	WIPM4702B	WIPM3020B	WIPM3120B	WIPM2731B	
<b>Description</b>	TV Socket Outlet, 1 Module	Buzzer, 2 Module	Blank Plate, 1 Module	Blank Plate, 2 Module	Satellite Socket	
<b>HSN</b>	85365090	85318000	85389000	85389000	85365090	
<b>Unit Sale Price Rs per number</b>	295	880	69	112	742	
<b>Maximum Retail Price (Inclusive of all taxes) Rs.</b>	5900	8800	3450	2240	7420	
<b>Standard Packing Quantity (Number)</b>	20	10	50	20	10	
						
<b>Code</b>	WIPM1341B	WIPM1343B	WIPM1443B	WIPM2641B	WIPM4822B	WIPM2311B
<b>Description</b>	USB-A Charger, Single Port(2.1A, 5V DC), 1 Module	18W, USB Type-A Fast Charger, 1 Module (CRS Certified)	18W, USB Power Delivery Charger(USB-C), 1 Module (CRS Certified)	High Definition Multimedia Interface Connector, 1 Module	Audio Video Socket, 1 Module	Projector Socket, 1 Module
<b>HSN</b>	85044090	85044090	85365090	85444999	85365090	85044090
<b>Unit Sale Price Rs per number</b>	2151	2411	2530	2398	1066	2801
<b>Maximum Retail Price (Inclusive of all taxes) Rs.</b>	43020	48220	50600	23980	10660	28010
<b>Standard Packing Quantity (Number)</b>	20	20	20	10	10	10

Hospitality Range (240V~50Hz)

						
<b>Code</b>	WIPM57812B	WIPM500212B	WIPM500213B	WIPM1051B	WIPM4013B / WIPM40131B	WIPM4014B / WIPM40141B
<b>Description</b>	20A, Electronic Key-card Unit with 30Sec time delay, 3 Module	DND MMR Internal unit ( DND Switch, MMR Switch), 2 Module	DND MMR External unit ( DND Indicator, MMR Indicator & Bell Push Switch), 2 Module	20VA, Shaver Socket with Transformer (With White Inner Frame), 4 Module	Foot Light - LED Based (Cool & Warm light), 3 Module	Foot Light - LED Based (Cool & Warm light), 4 Module
<b>HSN</b>	85365090	85365090	85365090	85365090	94054090	85444299
<b>Unit Sale Price Rs per number</b>	4124	1152	1536	4532	1112	1219
<b>Maximum Retail Price (Inclusive of all taxes) Rs.</b>	24744	5760	7680	22660	6672	7314
<b>Standard Packing Quantity (Number)</b>	6	5	5	5	6	6
						
<b>Code</b>	WIPM4661B	WIPM4791B				
<b>Description</b>	3.5 Modem Audio Jack, White	Bell Call Indicator, 1 Module				
<b>HSN</b>	85444299	85444299				
<b>Unit Sale Price Rs per number</b>	2130	573				
<b>Maximum Retail Price (Inclusive of all taxes) Rs.</b>	31950	5730				
<b>Standard Packing Quantity (Number)</b>	15	10				



10AX Switches (240V~50Hz), ISI

						
<b>Code</b>	WIPM5011S	WIPM5111S	WIPM5012S	WIPM50119S	WIPM51119S	WIPM5021S
<b>Description</b>	10AX, 1Way Switch, 1 Module	10AX, 1Way Switch with Indicator, 1 Module	10AX, 2Way Switch, 1 Module	10A, Bell Push Switch, 1 Module	10A, Bell Push Switch with Indicator, 1 Module	10AX, 1Way Switch, 2 Module
<b>HSN</b>	85361010	85361010	85361010	85361010	85361010	85361010
<b>Unit Sale Price Rs per number</b>	227	309	276	306	395	331
<b>Maximum Retail Price (Inclusive of all taxes) Rs.</b>	4540	6180	5520	6120	7900	3310
<b>Standard Packing Quantity (Number)</b>	20	20	20	20	20	10

					
<b>Code</b>	WIPM5121S	WIPM5022S	WIPM50219S	WIPM51219S	WIPM51319S
<b>Description</b>	10AX, 1Way Switch with Indicator, 2 Module	10AX, 2Way Switch, 2 Module	10A, Bell Push Switch, 2 Module	10A, Bell Push Switch with Indicator, 2 Module	10A, Bell Push Switch with Indicator, 3 Module
<b>HSN</b>	85361010	85361010	85361010	85361010	85361010
<b>Unit Sale Price Rs per number</b>	363	381	381	454	509
<b>Maximum Retail Price (Inclusive of all taxes) Rs.</b>	3630	3810	3810	4540	2545
<b>Standard Packing Quantity (Number)</b>	10	10	10	10	5

20A Switches (240V~50Hz), ISI

						
<b>Code</b>	WIPM50115S	WIPM51115S	WIPM50125S	WIPM50215S	WIPM51215S	WIPM50225S
<b>Description</b>	20A, 1Way Switch, 1 Module	20A, 1Way Switch with Indicator, 1 Module	20A, 2Way Switch, 1 Module	20A, 1Way Switch, 2 Module	20A, 1Way Switch with Indicator, 2 Module	20A, 2Way Switch, 2 Module
<b>HSN</b>	85361020	85361020	85361020	85361020	85361020	85361020
<b>Unit Sale Price Rs per number</b>	370	384	431	461	603	471
<b>Maximum Retail Price (Inclusive of all taxes) Rs.</b>	7400	7680	8620	4610	6030	4710
<b>Standard Packing Quantity (Number)</b>	20	20	20	10	10	10

			
<b>Code</b>	WIPM50315S	WIPM51315S	WIPM50325S
<b>Description</b>	20A, 1Way Switch, 3 Module	20A, 1Way Switch with Indicator, 3 Module	20A, 2Way Switch, 3 Module
<b>HSN</b>	85361020	85361020	85361020
<b>Unit Sale Price Rs per number</b>	541	677	667
<b>Maximum Retail Price (Inclusive of all taxes) Rs.</b>	2705	3385	3335
<b>Standard Packing Quantity (Number)</b>	5	5	5

Power Switches - Heavy Duty (240V~50Hz), ISI

		
<b>Code</b>	WIPM51113S	WIPM51234S
<b>Description</b>	25A, S.P, 1Way Switch with Indicator, 1 Module	32A, D.P, 1Way Switch with Indicator, 2 Module
<b>HSN</b>	85361020	85361020
<b>Unit Sale Price Rs per number</b>	689	1206
<b>Maximum Retail Price (Inclusive of all taxes) Rs.</b>	6890	12060
<b>Standard Packing Quantity (Number)</b>	10	10

Sockets With Safety Shutter (240V~50Hz)



<b>Code</b>	WIPM113214S	WIPM123214S	WIPM125214S	WIPM155314S
<b>Description</b>	6A, 3Pin Socket ( ISI ), 2 Module	16A, 3Pin Socket ( ISI ), 2 Module	16A/6A, Twin Socket, (ISI Mark), 2 Module	Twin Socket, 3 Module (ISI Mark), 6A/16A, 240V~
<b>HSN</b>	85366910	85366910	85366910	85366910
<b>Unit Sale Price Rs per number</b>	<b>321</b>	<b>528</b>	<b>635</b>	<b>741</b>
<b>Maximum Retail Price (Inclusive of all taxes) Rs.</b>	3210	5280	6350	7410
<b>Standard Packing Quantity (Number)</b>	10	10	10	10



<b>Code</b>	WIPM4734S
<b>Description</b>	25A, Motor Starter Switch, 2 Module
<b>HSN</b>	85395000
<b>Unit Sale Price Rs per number</b>	<b>879</b>
<b>Maximum Retail Price (Inclusive of all taxes) Rs.</b>	8790
<b>Standard Packing Quantity (Number)</b>	10

Fan Regulators & Dimmers (240V~50Hz)







<b>Code</b>	WIPM4951S	WIPM4952S	WIPM495214S	WIPM5714S	WIPM5726S
<b>Description</b>	100W, Step Fan Regulator, 1 Module	100W, Step Fan Regulator, 2 Module	100W, Step Fan Regulator, 2 Module (ISI)	450W, Dimmer, 1 Module	650W, Dimmer, 2 Module
<b>HSN</b>	84149030	84149030	84149030	85365020	85365020
<b>Unit Sale Price Rs per number</b>	<b>878</b>	<b>1215</b>	<b>1264</b>	<b>1046</b>	<b>1281</b>
<b>Maximum Retail Price (Inclusive of all taxes) Rs.</b>	17560	12150	12640	20920	12810
<b>Standard Packing Quantity (Number)</b>	20	10	10	20	10







Hospitality Range (240V~50Hz)









<b>Code</b>	WIPM2164S	WIPM2264S	WIPM2499S	WIPM2488S	WIPM24886S	WIPM3023S
<b>Description</b>	RJ11, Tel Jack, Single with Shutter, 1 Module	RJ11, Tel Jack, Double w/o Shutter, 1 Module	RJ45, Receptor, 1 Module	RJ45, Computer Socket, Cat 5e, 1 Module	RJ45, Computer Socket, Cat 6, 1 Module	Cord Outlet with Grip, 1 Module
<b>HSN</b>	85366910	85366910	85366910	85366910	85366910	85366910
<b>Unit Sale Price Rs per number</b>	<b>284</b>	<b>474</b>	<b>278</b>	<b>908</b>	<b>1065</b>	<b>319</b>
<b>Maximum Retail Price (Inclusive of all taxes) Rs.</b>	5680	9480	5560	18160	21300	6380
<b>Standard Packing Quantity (Number)</b>	20	20	20	20	20	20



Support Modules (240V ~50Hz)

					
<b>Code</b>	WIPM2501S	WIPM4702S	WIPM3020S	WIPM3120S	WIPM2731S
<b>Description</b>	TV Socket Outlet, 1 Module	Buzzer, 2 Module	Blank Plate, 1 Module	Blank Plate, 2 Module	Satellite Socket
<b>HSN</b>	85365090	85318000	85389000	85389000	85365090
<b>Unit Sale Price Rs per number</b>	295	880	69	112	742
<b>Maximum Retail Price (Inclusive of all taxes) Rs.</b>	5900	8800	3450	2240	7420
<b>Standard Packing Quantity (Number)</b>	20	10	50	20	10

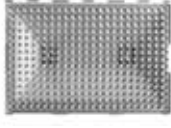
						
<b>Code</b>	WIPM1341S	WIPM1343S	WIPM1443S	WIPM2641S	WIPM4822S	WIPM2311S
<b>Description</b>	USB-A Charger, Single Port(2.1A, 5V DC), 1 Module	18W, USB Type-A Fast Charger, 1 Module (CRS Certified)	18W, USB Power Delivery Charger(USB-C), 1 Module (CRS Certified)	High Definition Multimedia Interface Connector, 1 Module	Audio Video Socket, 1 Module	Projector Socket, 1 Module
<b>HSN</b>	85044090	85044090	85365090	85444999	85365090	85044090
<b>Unit Sale Price Rs per number</b>	2151	2411	2530	2398	1066	2801
<b>Maximum Retail Price (Inclusive of all taxes) Rs.</b>	43020	48220	50600	23980	10660	28010
<b>Standard Packing Quantity (Number)</b>	20	20	20	10	10	10

Hospitality Range (240V ~50Hz)

						
<b>Code</b>	WIPM57812S	WIPM500212S	WIPM500213S	WIPM1051S	WIPM4013S / WIPM40131S	WIPM4014S / WIPM40141S
<b>Description</b>	20A, Electronic Key-card Unit with 30Sec time delay, 3 Module	DND MMR Internal unit ( DND Switch, MMR Switch), 2 Module	DND MMR External unit ( DND Indicator, MMR Indicator & Bell Push Switch), 2 Module	20VA, Shaver Socket with Transformer (With White Inner Frame), 4Module	Foot Light - LED Based (Cool & Warm light), 3 Module	Foot Light - LED Based (Cool & Warm light), 4 Module
<b>HSN</b>	85365090	85365090	85365090	85365090	94054090	85444299
<b>Unit Sale Price Rs per number</b>	4124	1152	1536	4532	1112	1219
<b>Maximum Retail Price (Inclusive of all taxes) Rs.</b>	24744	5760	7680	22660	6672	7314
<b>Standard Packing Quantity (Number)</b>	6	5	5	5	6	6

		
<b>Code</b>	WIPM4661S	WIPM4791S
<b>Description</b>	3.5 Modulem Audio Jack, Silver	Bell Call Indicator, 1 Module
<b>HSN</b>	85444299	85444299
<b>Unit Sale Price Rs per number</b>	2130	573
<b>Maximum Retail Price (Inclusive of all taxes) Rs.</b>	21300	5730
<b>Standard Packing Quantity (Number)</b>	10	10

10AX Switches (240V~50Hz), ISI



<b>Code</b>	WIPM5011GB	WIPM5111GB	WIPM5012GB	WIPM50119GB	WIPM51119GB	WIPM5021GB
<b>Description</b>	10AX, 1Way Switch, 1 Module	10AX, 1Way Switch with Indicator, 1 Module	10AX, 2Way Switch, 1 Module	10A, Bell Push Switch, 1 Module	10A, Bell Push Switch with Indicator, 1 Module	10AX, 1Way Switch, 2 Module
<b>HSN</b>	85361010	85361010	85361010	85361010	85361010	85361010
<b>Unit Sale Price Rs per number</b>	227	309	276	306	395	331
<b>Maximum Retail Price (Inclusive of all taxes) Rs.</b>	4540	6180	5520	6120	7900	3310
<b>Standard Packing Quantity (Number)</b>	20	20	20	20	20	10



<b>Code</b>	WIPM5121GB	WIPM5022GB	WIPM50219GB	WIPM51219GB	WIPM51319GB
<b>Description</b>	10AX, 1Way Switch with Indicator, 2 Module	10AX, 2Way Switch, 2 Module	10A, Bell Push Switch, 2 Module	10A, Bell Push Switch with Indicator, 2 Module	10A, Bell Push Switch with Indicator, 3 Module
<b>HSN</b>	85361010	85361010	85361010	85361010	85361010
<b>Unit Sale Price Rs per number</b>	363	381	381	454	509
<b>Maximum Retail Price (Inclusive of all taxes) Rs.</b>	3630	3810	3810	4540	2545
<b>Standard Packing Quantity (Number)</b>	10	10	10	10	5

20A Switches (240V~50Hz), ISI



<b>Code</b>	WIPM50115GB	WIPM51115GB	WIPM50125GB	WIPM50215GB	WIPM51215GB	WIPM50225GB
<b>Description</b>	20A, 1Way Switch, 1 Module	20A, 1Way Switch with Indicator, 1 Module	20A, 2Way Switch, 1 Module	20A, 1Way Switch, 2 Module	20A, 1Way Switch with Indicator, 2 Module	20A, 2Way Switch, 2 Module
<b>HSN</b>	85361020	85361020	85361020	85361020	85361020	85361020
<b>Unit Sale Price Rs per number</b>	370	384	431	461	603	471
<b>Maximum Retail Price (Inclusive of all taxes) Rs.</b>	7400	7680	8620	4610	6030	4710
<b>Standard Packing Quantity (Number)</b>	20	20	20	10	10	10



<b>Code</b>	WIPM50315GB	WIPM51315GB	WIPM50325GB
<b>Description</b>	20A, 1Way Switch, 3 Module	20A, 1Way Switch with Indicator, 3 Module	20A, 2Way Switch, 3 Module
<b>HSN</b>	85361020	85361020	85361020
<b>Unit Sale Price Rs per number</b>	541	677	667
<b>Maximum Retail Price (Inclusive of all taxes) Rs.</b>	2705	3385	3335
<b>Standard Packing Quantity (Number)</b>	5	5	5

Power Switches - Heavy Duty (240V~50Hz), ISI



<b>Code</b>	WIPM51113GB	WIPM51234GB
<b>Description</b>	25A, S.P, 1Way Switch with Indicator, 1 Module	32A, D.P, 1Way Switch with Indicator, 2 Module
<b>HSN</b>	85361020	85361020
<b>Unit Sale Price Rs per number</b>	689	1206
<b>Maximum Retail Price (Inclusive of all taxes) Rs.</b>	6890	12060
<b>Standard Packing Quantity (Number)</b>	10	10

Sockets With Safety Shutter (240V~50Hz)



<b>Code</b>	WIPM113214GB	WIPM123214GB	WIPM125214GB	WIPM155314GB
<b>Description</b>	6A, 3Pin Socket ( ISI ), 2 Module	16A, 3Pin Socket ( ISI ), 2 Module	16A/6A, Twin Socket, (ISI Mark), 2 Module	Twin Socket, 3 Module (ISI Mark), 6A/16A, 240V~
<b>HSN</b>	85366910	85366910	85366910	85366910
<b>Unit Sale Price Rs per number</b>	<b>321</b>	<b>528</b>	<b>635</b>	<b>741</b>
<b>Maximum Retail Price (Inclusive of all taxes) Rs.</b>	3210	5280	6350	7410
<b>Standard Packing Quantity (Number)</b>	10	10	10	10



<b>Code</b>	WIPM4734GB
<b>Description</b>	25A, Motor Starter Switch, 2 Module
<b>HSN</b>	85395000
<b>Unit Sale Price Rs per number</b>	<b>879</b>
<b>Maximum Retail Price (Inclusive of all taxes) Rs.</b>	8790
<b>Standard Packing Quantity (Number)</b>	10

Fan Regulators & Dimmers (240V~50Hz)







<b>Code</b>	WIPM4951GB	WIPM4952GB	WIPM495214GB	WIPM5714GB	WIPM5726GB
<b>Description</b>	100W, Step Fan Regulator, 1 Module	100W, Step Fan Regulator, 2 Module	100W, Step Fan Regulator, 2 Module (ISI)	450W, Dimmer, 1 Module	650W, Dimmer, 2 Module
<b>HSN</b>	84149030	84149030	84149030	85365020	85365020
<b>Unit Sale Price Rs per number</b>	<b>878</b>	<b>1215</b>	<b>1264</b>	<b>1046</b>	<b>1281</b>
<b>Maximum Retail Price (Inclusive of all taxes) Rs.</b>	17560	12150	12640	20920	12810
<b>Standard Packing Quantity (Number)</b>	20	10	10	20	10







Hospitality Range (240V~50Hz)









<b>Code</b>	WIPM2164GB	WIPM2264GB	WIPM2499GB	WIPM2488GB	WIPM24886GB	WIPM3023GB
<b>Description</b>	RJ11, Tel Jack, Single with Shutter, 1 Module	RJ11, Tel Jack, Double w/o Shutter, 1 Module	RJ45, Receptor, 1 Module	RJ45, Computer Socket, Cat 5e, 1 Module	RJ45, Computer Socket, Cat 6, 1 Module	Cord Outlet with Grip, 1 Module
<b>HSN</b>	85366910	85366910	85366910	85366910	85366910	85366910
<b>Unit Sale Price Rs per number</b>	<b>284</b>	<b>474</b>	<b>278</b>	<b>908</b>	<b>1065</b>	<b>319</b>
<b>Maximum Retail Price (Inclusive of all taxes) Rs.</b>	5680	9480	5560	18160	21300	6380
<b>Standard Packing Quantity (Number)</b>	20	20	20	20	20	20



Support Modules (240V ~50Hz)

					
<b>Code</b>	WIPM2501GB	WIPM4702GB	WIPM3020GB	WIPM3120GB	WIPM2731GB
<b>Description</b>	TV Socket Outlet, 1 Module	Buzzer, 2 Module	Blank Plate, 1 Module	Blank Plate, 2 Module	Satellite Socket
<b>HSN</b>	85365090	85318000	85389000	85389000	85365090
<b>Unit Sale Price Rs per number</b>	295	880	69	112	742
<b>Maximum Retail Price (Inclusive of all taxes) Rs.</b>	5900	8800	3450	2240	7420
<b>Standard Packing Quantity (Number)</b>	20	10	50	20	10

						
<b>Code</b>	WIPM1341GB	WIPM1343GB	WIPM1443GB	WIPM2641GB	WIPM4822GB	WIPM2311GB
<b>Description</b>	USB-A Charger, Single Port(2.1A, 5V DC), 1 Module	18W, USB Type-A Fast Charger, 1 Module (CRS Certified)	18W, USB Power Delivery Charger(USB-C), 1 Module (CRS Certified)	High Definition Multimedia Interface Connector, 1 Module	Audio Video Socket, 1 Module	Projector Socket, 1 Module
<b>HSN</b>	85044090	85044090	85365090	85444999	85365090	85044090
<b>Unit Sale Price Rs per number</b>	2151	2411	2530	2398	1066	2801
<b>Maximum Retail Price (Inclusive of all taxes) Rs.</b>	43020	48220	50600	23980	10660	28010
<b>Standard Packing Quantity (Number)</b>	20	20	20	10	10	10

Hospitality Range (240V ~50Hz)

						
<b>Code</b>	WIPM57812GB	WIPM500212GB	WIPM500213GB	WIPM1051GB	WIPM4013GB / WIP-M40131GB	WIPM4014GB / WIP-M40141GB
<b>Description</b>	20A, Electronic Key-card Unit with 30Sec time delay, 3 Module	DND MMR Internal unit ( DND Switch, MMR Switch), 2 Module	DND MMR External unit ( DND Indicator, MMR Indicator & Bell Push Switch), 2 Module	20VA, Shaver Socket with Transformer (With White Inner Frame), 4Module	Foot Light - LED Based (Cool & Warm light), 3 Module	Foot Light - LED Based (Cool & Warm light), 4 Module
<b>HSN</b>	85365090	85365090	85365090	85365090	94054090	85444299
<b>Unit Sale Price Rs per number</b>	4124	1152	1536	4532	1112	1219
<b>Maximum Retail Price (Inclusive of all taxes) Rs.</b>	24744	5760	7680	22660	6672	7314
<b>Standard Packing Quantity (Number)</b>	6	5	5	5	6	6

		
<b>Code</b>	WIPM4661GB	WIPM4791GB
<b>Description</b>	3.5 Modem Audio Jack, Silver	Bell Call Indicator, 1 Module
<b>HSN</b>	85444299	85444299
<b>Unit Sale Price Rs per number</b>	2130	573
<b>Maximum Retail Price (Inclusive of all taxes) Rs.</b>	21300	5730
<b>Standard Packing Quantity (Number)</b>	10	10



**CLEAR PLATES**

(HSN Code - 85381090)



Gold



Brushed Aluminium

COLOUR	MODULE	1 Module	2 Module	3 Module	4 Module	6 Module	8 Module Horizontal	8 Module Square	12 Module	16 Module	18 Module
Gold	CODE	WIPM-6011MGD	WIPM-6012MGD	WIPM-6013MGD	WIPM-6014MGD	WIPM-6016MGD	WIPM-6018MGD	WIPM-6024MGD	WIPM-6026MGD	WIPM-6028MGD	WIPM-6036MGD
<b>Unit Sale Price Rs per number</b>		<b>1296</b>	<b>1296</b>	<b>1569</b>	<b>1838</b>	<b>2651</b>	<b>3234</b>	<b>3234</b>	<b>4439</b>	<b>5020</b>	<b>5371</b>
<b>Maximum Retail Price (Inclusive of all taxes) Rs.</b>		6480	6480	7845	9190	13255	16170	16170	22195	25100	26855
Brushed Aluminium	CODE	WIP-M6011MBA	WIP-M6012MBA	WIP-M6013MBA	WIP-M6014MBA	WIP-M6016MBA	WIP-M6018MBA	WIP-M6024MBA	WIP-M6026MBA	WIP-M6028MBA	WIP-M6036MBA
<b>Unit Sale Price Rs per number</b>		<b>1118</b>	<b>1118</b>	<b>1438</b>	<b>1687</b>	<b>2431</b>	<b>2964</b>	<b>2964</b>	<b>4069</b>	<b>4603</b>	<b>4925</b>
<b>Maximum Retail Price (Inclusive of all taxes) Rs.</b>		5590	5590	7190	8435	12155	14820	14820	20345	23015	24625
<b>Standard Packing Quantity (Number)</b>		5	5	5	5	5	5	5	5	5	5

**Weatherproof Box (IP55)**



Code	WIPM6812H	WIPM6813H	WIPM6814H
<b>Description</b>	2M, Weatherproof Box (IP55)	3M, Weatherproof Box (IP55)	4M, Weatherproof Box (IP55)
<b>HSN</b>	85365090	85365090	85365090
<b>Unit Sale Price Rs per number</b>	<b>1706</b>	<b>1826</b>	<b>1947</b>
<b>Maximum Retail Price (Inclusive of all taxes) Rs.</b>	1	1	1
<b>Standard Packing Quantity (Number)</b>	1706	1826	1947

Do not use "Hard cleaning Agent" for cleaning purpose

Note : Antimicrobial series is also available through pre order





# Panasonic

## TERMS AND CONDITIONS

- 1) Prices are in INR (₹).
- 2) All prices are subject to the general terms and conditions of our business.
- 3) Prices are subject to change without prior notice.
- 4) This price list supersedes all our previous price lists.
- 5) If any dispute should arise it will be subject to Thane jurisdiction.
- 6) Company reserves the right to issue amendments which may arise due to any errors in the price list.
- 7) Colour in images are for reference purpose only, please see product for actual colour.

Due to continuous improvements in product design and development and manufacturing methods, the product may differ in some aspects from the details provided herein.

## PANASONIC LIFE SOLUTIONS INDIA PVT LTD.

**Corporate & Head Office:** 3rd Floor, B Wing, I-Think Techno Campus,  
Pokharan Road No.2, Thane (W), Thane - 400 607, Maharashtra.

Tel 022 4222 8888 | Fax 022 4222 8884

Customer Care no.: 022-41304130 | WhatsApp: 9136028606

Email: [wecare@in.panasonic.com](mailto:wecare@in.panasonic.com) | [www.isin.panasonic.com](http://www.isin.panasonic.com)

**Registered Office:** 12th Floor, Ambience Tower, Ambience Island,  
NH-48, Gurugram - 122 002, Haryana.

Dealer Stamp